

RECORD OF SURVEY FOR PROPERTY LINE ADJUSTMENT A PORTION OF THE SW 1/4 OF SECTION 3, TOWNSHIP 1 SOUTH, RANGE 24 EAST, W.M., MORROW COUNTY, OREGON

SURVEYOR'S NOTES:

- BASIS OF BEARING IS GRID, OREGON STATE PLANE, NORTH ZONE, NAD83(11), BASED ON GNSS OBSERVATIONS. DISTANCES ARE "GROUND" SCALED FROM GRID USING A COMBINED FACTOR OF 0.99985253 (1.000147492) AT LATITUDE: 45°30'15.52"N LONGITUDE: 119°49'35.10"W
- = DENOTES FOUND 5/8" REBAR W/ YELLOW PLASTIC CAP STAMPED "EDWARDS, 951, SET PER (R1) OR MONUMENT AS NOTED
- = DENOTES SET 5/8"x30" REBAR W/ BLUE PLASTIC CAP STAMPED "GRIFFIN RSI LS93754"
- ⊙ = DENOTES FOUND MONUMENT AS NOTED
- ⊗ = DENOTES MONUMENT NOT SEARCHED FOR
- ⊠ = DENOTES FOUND 5/8" REBAR W/ 1-1/2" ALUMINUM CAP ±2.5 WEST OF SIGN POST STAMPED "OREG. STATE HWY. DEPT." OR MONUMENT AS NOTED
- $\frac{4}{9} \frac{3}{10}$ = DENOTES FOUND SECTION, OR QUARTER, CORNER AS NOTED
- $\frac{9}{16} \frac{10}{15}$ = DENOTES COMPUTED SECTION, OR QUARTER, CORNER AS NOTED
- (M) = MEASURED PER THIS SURVEY (C) = COMPUTED
(R#) = RECORD PER SURVEY REFERENCE, SEE REFERENCE TABLE
(D#) = RECORD PER DEED REFERENCE, SEE REFERENCE TABLE
(P#) = RECORD PER PLAT REFERENCE, SEE REFERENCE TABLE
[] = RECORD PER GLO PLAT BY THOMPSON MAR. 1, 1865
- EQUIPMENT AND PROCEDURES: THIS SURVEY WAS PERFORMED WITH DUAL FREQUENCY GNSS RECEIVERS CONFIGURED FOR REAL TIME KINEMATIC SURVEYING. GNSS OBSERVATIONS WERE PROCESSED USING NATIONAL GEODETIC SURVEY ONLINE POSITIONAL USER SERVICE (OPUS)
- CORNER FORMS WILL BE FILED SEPARATELY FOR ESTABLISHED SECTION CORNERS AND QUARTER CORNERS BEING SET THIS SURVEY

REFERENCES:

- (R1) = RECORD PER PLAT OF EMERT SUBDIVISION, SURVEY NO. C-1019-E (FOLDER 791)
- (R2) = RECORD PER SURVEY NO. D-1078-E (FOLDER 851)
- (R3) = RECORD PER SURVEY NO. 2015-1744C (FOLDER 1744)
- (R4) = RECORD PER SURVEY NO. B-658-K (FOLDER 238)
- (R5) = RECORD PER SURVEY NO. B-841-K (FOLDER 258)
- (R6) = RECORD PER SURVEY NO. B-1035-E (FOLDER 808)
- (R7) = RECORD PER SURVEY NO. 2015-1730D (FOLDER 1730)
- (R8) = RECORD PER SURVEY NO. 2014-1699C (FOLDER 1699)
- (R9) = RECORD PER SURVEY NO. B-896-E (FOLDER 683)
- (R10) = RECORD PER SURVEY NO. 1561-C (FOLDER 1561)
- (R11) = RECORD PER SURVEY (FOLDER 1173)
- (R12) = OREGON STATE HIGHWAY DEPARTMENT DRAWING NO. 4B-2-4
- (R13) = OREGON STATE HIGHWAY DEPARTMENT DRAWING NO. 7B-6-15
- (R14) = OREGON STATE HIGHWAY DEPARTMENT DRAWING NO. 7B-6-16
- (R15) = OREGON STATE HIGHWAY DEPARTMENT DRAWING NO. 9B-21-9
- (R16) = OREGON STATE HIGHWAY DEPARTMENT DRAWING NO. 9B-21-19
- (R17) = NGS DATASHEET FOR PID R80868
- (R18) = RECORD PER CORNER RESTORATION FORM A13, T1S, R24E, SURVEY 2014-1699C
- (R19) = RECORD PER CORNER RESTORATION FORM A17, T1S, R24E, SURVEY 2014-1699C
- (R20) = RECORD PER PARTITION PLAT 2007-05, SURVEY NO. 1502-C (FOLDER 1502)
- (R21) = RECORD PER PARTITION PLAT 2007-01, SURVEY NO. 1494-C (FOLDER 1494)
- (R22) = RECORD PER PARTITION PLAT 2002-10, SURVEY NO. C-1357-M (FOLDER 1357)
- (R23) = O.W.R.&N.CO. RIGHT-OF-WAY AND TRACK MAP V-ORE.8 08, REVISED 12/31/1921
- (R24) = OREGON STATE HIGHWAY DEPARTMENT DRAWING NO. 3B-11-14
- (D1) = RECORD PER WARRANTY DEED (M-40423)
- (D2) = RECORD PER QUIT CLAIM DEED (M-46070)
- (D3) = RECORD PER STATUTORY BARGAIN AND SALE DEED (2007-20757)
- (D4) = RECORD PER BARGAIN AND SALE DEED (2014-34269)
- (D5) = RECORD PER STATUTORY WARRANTY DEED (2009-24234)
- (D6) = RECORD PER SPECIAL WARRANTY DEED (2019-43801)
- (P1) = RECORD PER PLAT OF CLUFF'S FIFTH ADDITION
- (P2) = RECORD PER PLAT OF CLUFF'S SIXTH ADDITION
- (P3) = RECORD PER PLAT OF CLUFF'S SEVENTH ADDITION
- (P4) = RECORD PER PLAT OF CLUFF'S EIGHTH ADDITION

RECEIVED BY
Morrow County Surveyor
Date: 6-24-22
Rec'd By: MPK
No.: 2022-1994C
Folder No.: 1994

REGISTERED PROFESSIONAL LAND SURVEYOR
Brenton A. Griffin
OREGON
MARCH 09, 2021
BRENTON A. GRIFFIN
93754PLS
DATE: 6/06/2022

RENEWS: 06/30/2023 REV: 6/03/22 BAG

CLIENT	IONE SCHOOL DISTRICT	JOB	06622
PROJECT	PROPERTY LINE ADJUSTMENT PTN SW1/4 SEC 3, T.1S., R24E., W.M.	DRN. BY	BAG
SCALE	1"=1000'	ACAD VER	-C3021
DATE	4/12/2022	FILE:	06622.DWG
SHEET	1	OF	4

RSI ROGERS SURVEYING INC., P.S.
1455 COLUMBIA PARK TRAIL
RICHLAND, WA. 99352
PHONE (509) 783-4141
FAX: (509) 783-8994
www.rogerssurveying.com

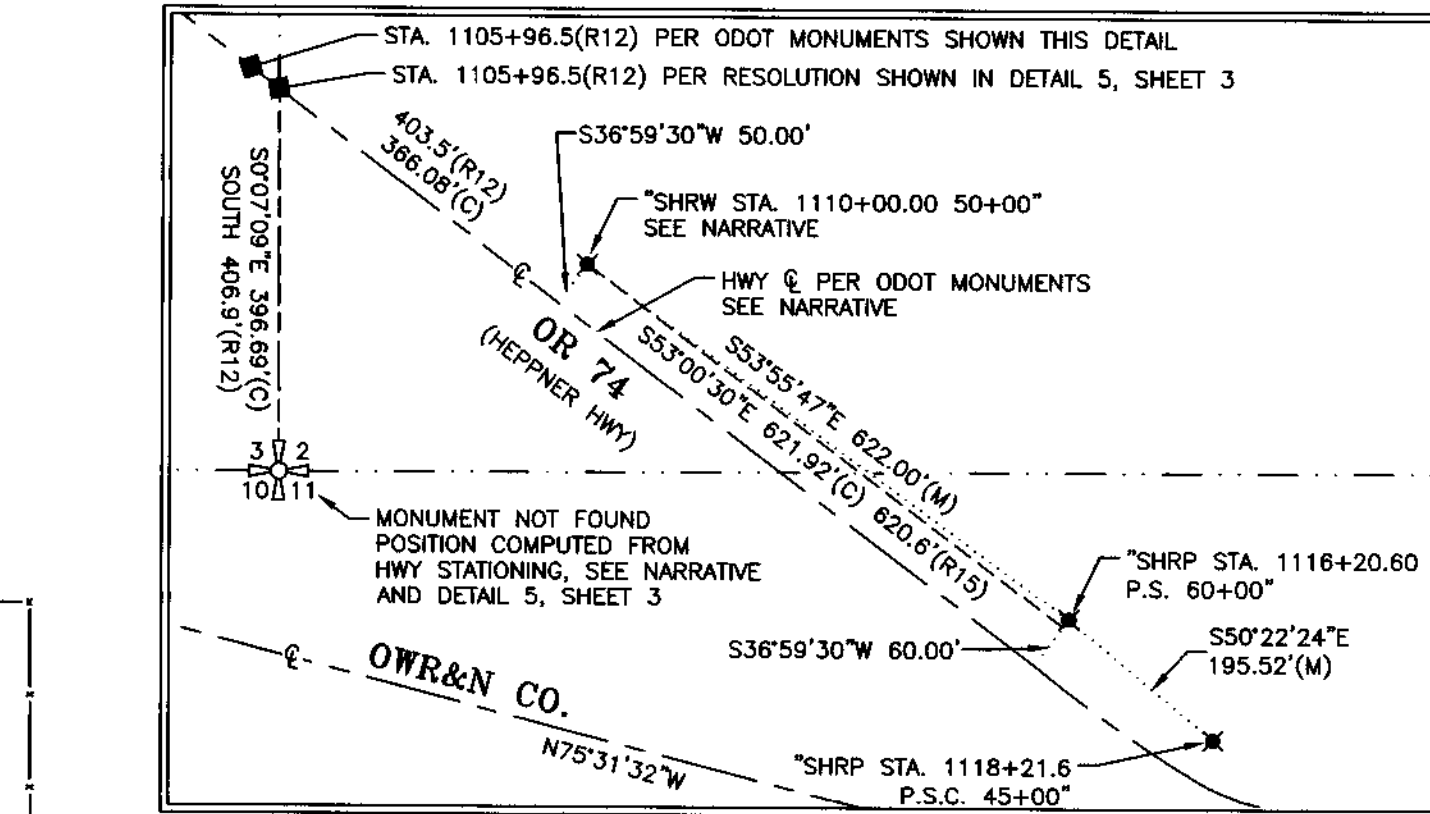

DETAIL 1
SCALE: 1"=200'

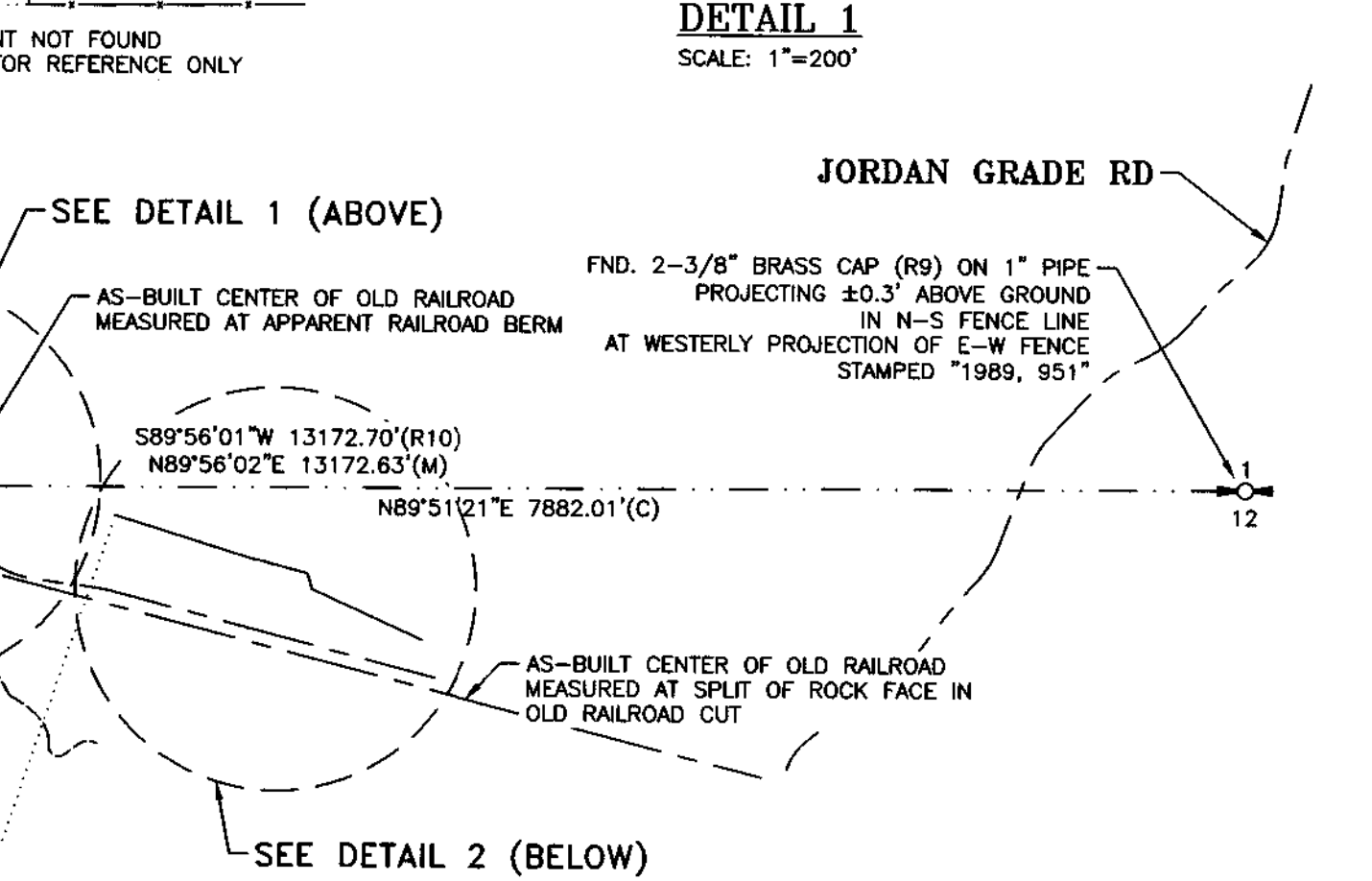

DETAIL 2
SCALE: 1"=300'

CURVE	LENGTH	RADIUS	DELTA	CH. BRNG.	CHORD	RADIUS (R)	DELTA (R)	LENGTH (R)
C1	1767.28	5729.65	17°40'21"	N84°21'43"W	1760.28	1°CR(5729.65')	17°42'	1770

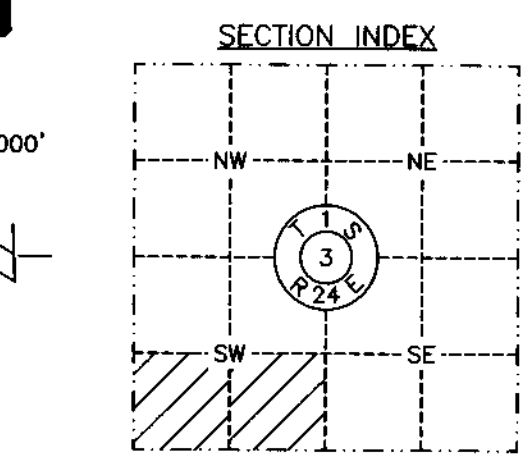
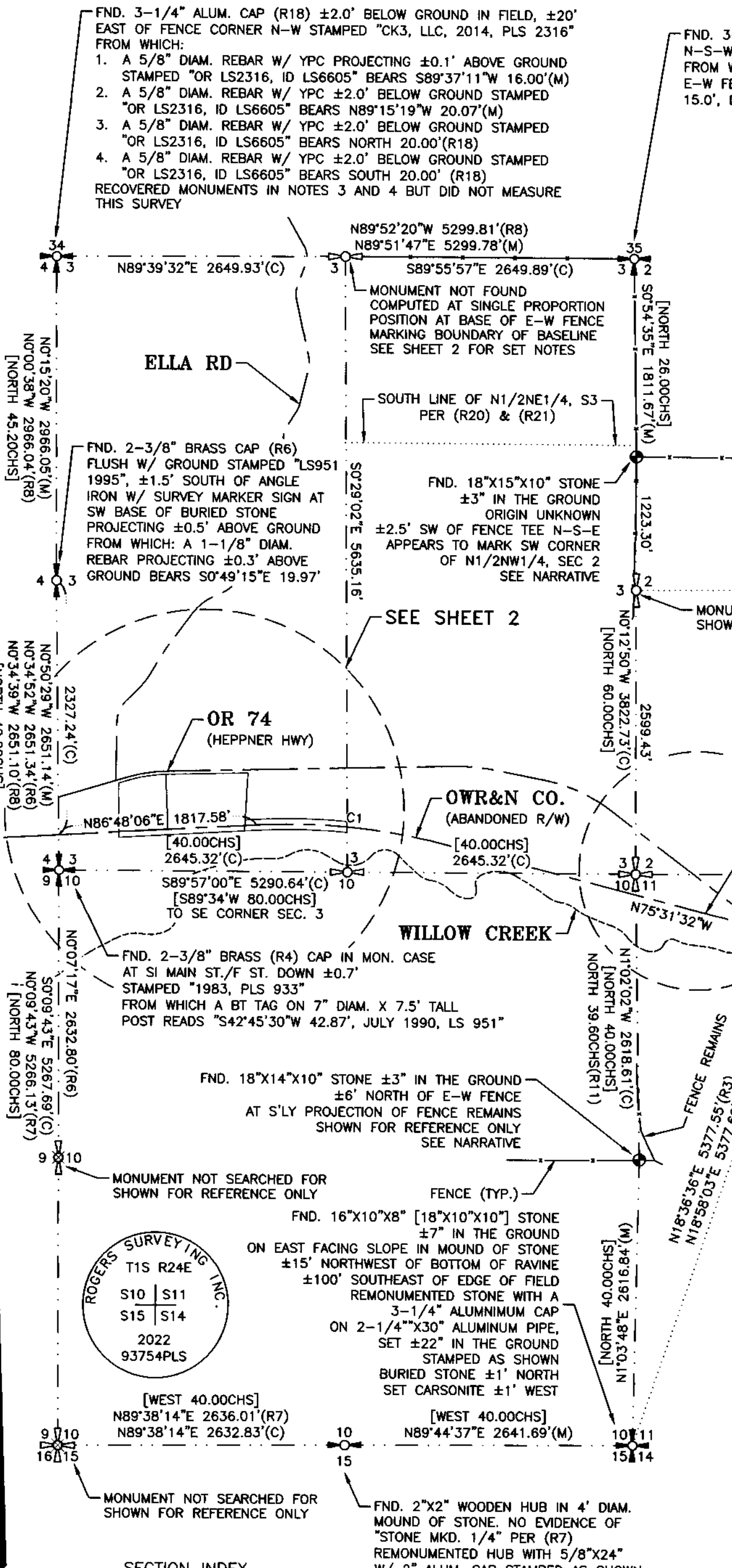

ROGERS SURVEYING INC.
T1S R24E
S10 S11
S15 S14
2022
93754PLS

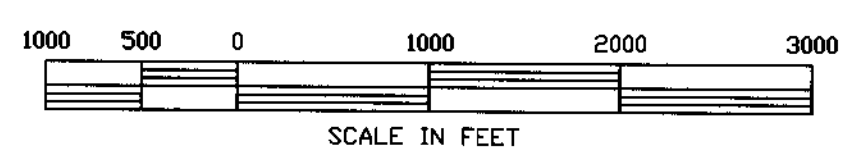

1994

RECORD OF SURVEY FOR PROPERTY LINE ADJUSTMENT A PORTION OF THE SW 1/4 OF SECTION 3, TOWNSHIP 1 SOUTH, RANGE 24 EAST, W.M., MORROW COUNTY, OREGON

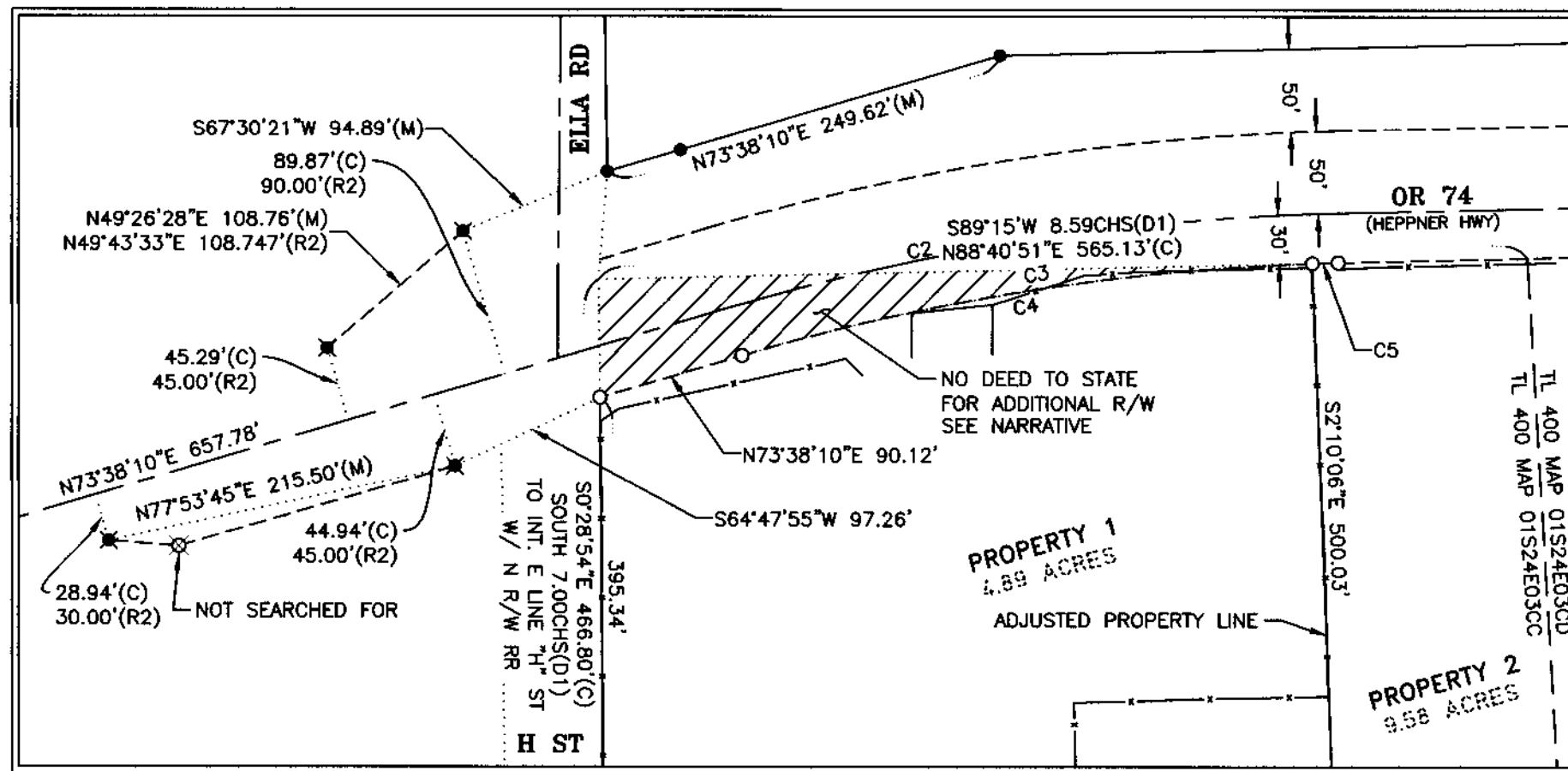
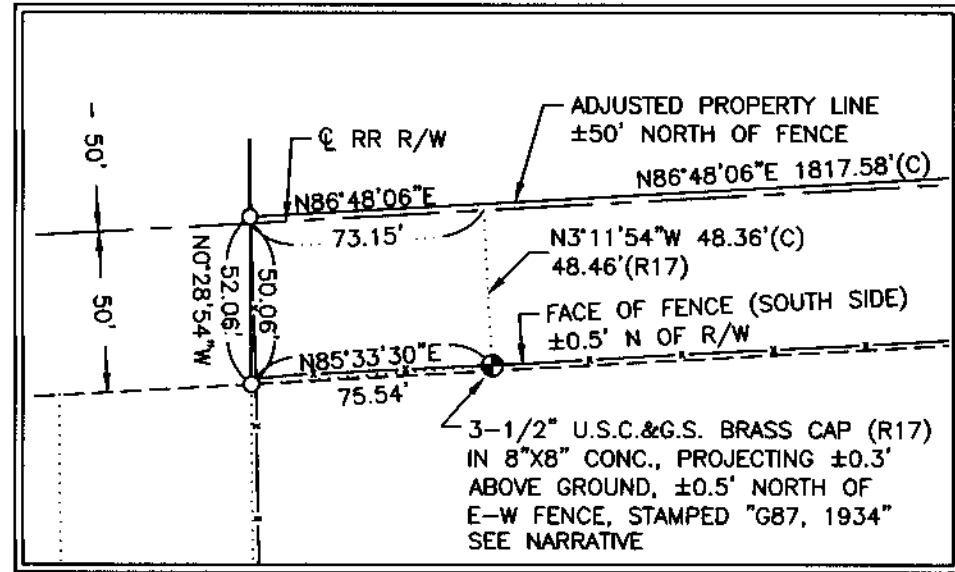

Curve Table					
CURVE	LENGTH	RADIUS	DELTA	CH. BRNG.	CHORD
C1	1767.28	5729.65	17°40'21"	N84°21'43"W	1760.28
C2	376.11	1432.39	15°02'40"	S81°09'30"W	375.03
C3	368.24	1402.39	15°02'40"	S81°09'30"W	367.18
C4	352.54	1402.39	14°24'11"	S80°50'16"W	351.61
C5	15.70	1402.39	0°38'29"	S88°21'36"W	15.70
C6	104.98	5779.65	1°02'26"	S87°19'20"W	104.97
C7	204.58	5779.65	2°01'41"	S88°51'23"W	204.57
C8	309.05	5779.65	3°03'49"	N88°35'51"W	309.01
C9	216.43	5779.65	2°08'44"	N85°59'35"W	216.42
C10	830.33	5679.65	8°22'35"	N89°00'36"W	829.59

RECEIVED BY
Morrow County Surveyor

Date: 6-24-22

Rec'd By: MPK

No.: 2022-1994C

Folder No.: 1994

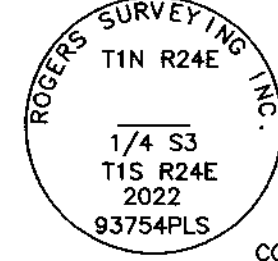

MONUMENT NOT FOUND
SET 5/8"x30" REBAR
W/ 2" ALUMINUM CAP
STAMPED AS SHOWN
COMPUTED AT SINGLE PROPORTION
AT SOUTH BASE OF E-W FENCE
MARKING BOUNDARY OF BASELINE
SET CARSONITE ±0.4' NORTH

1"=200'

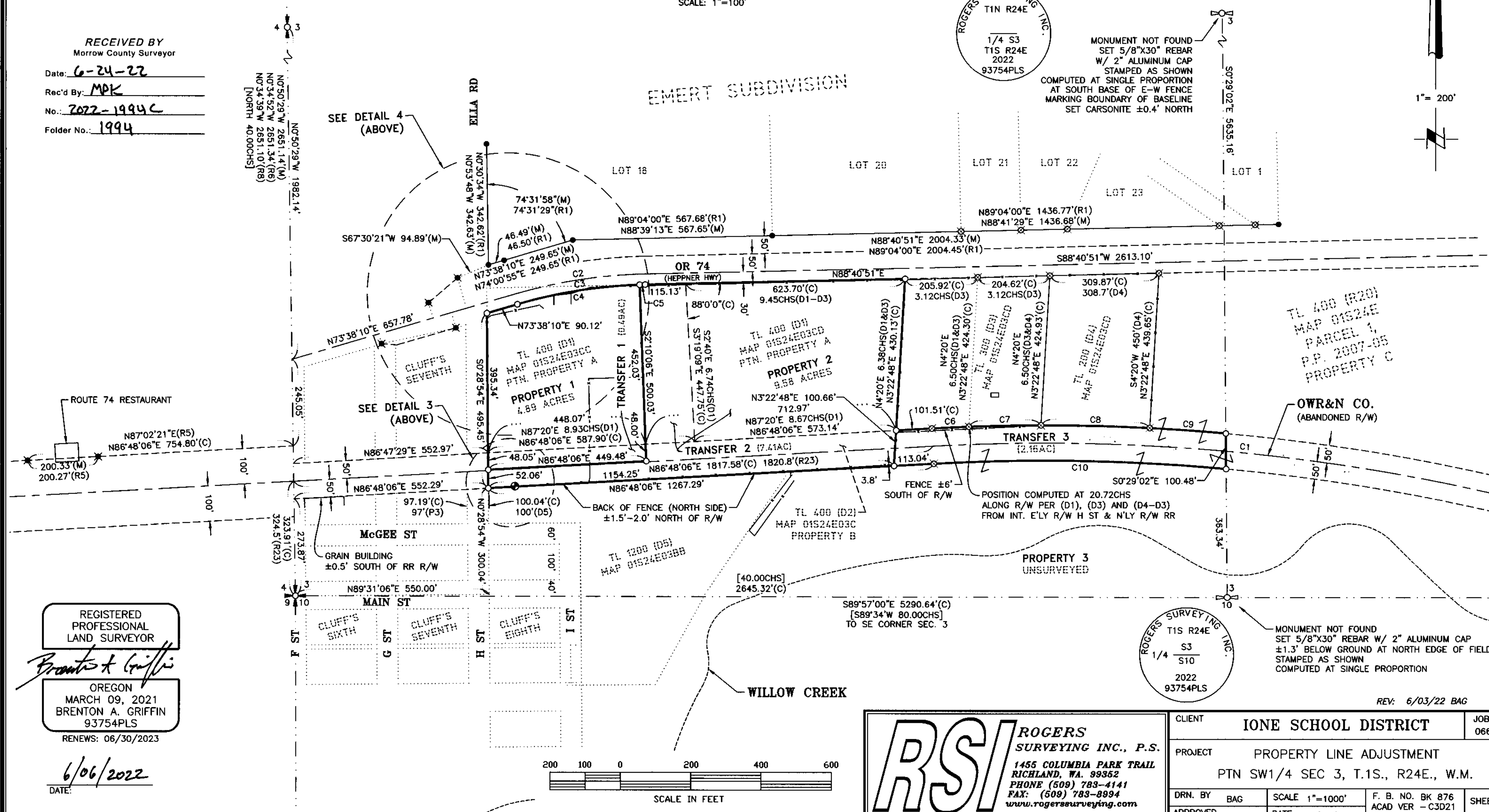

REGISTERED
PROFESSIONAL
LAND SURVEYOR

Brenton A. Griffin

OREGON
MARCH 09, 2021
BRENTON A. GRIFFIN
93754PLS

RENEWS: 06/30/2023

DATE: 6/06/2022

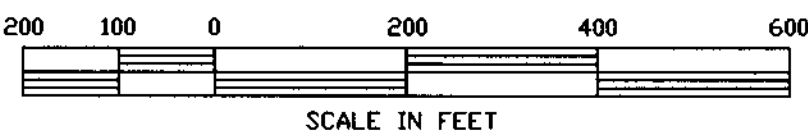

RSI ROGERS SURVEYING INC., P.S.
1455 COLUMBIA PARK TRAIL
RICHLAND, WA. 99352
PHONE (509) 783-4141
FAX: (509) 783-8994
www.rogerssurveying.com

CLIENT	IONE SCHOOL DISTRICT	JOB	06622
PROJECT	PROPERTY LINE ADJUSTMENT PTN SW1/4 SEC 3, T.1S., R24E., W.M.	DRN. BY	BAG
SCALE	1"=1000'	APPROVED	BAG
DATE	4/12/2022	F. B. NO.	BK 876
FILE	06622.DWG	ACAD VER	-C3D21
		FILE	06622.DWG
		SHEET	2 OF 4

1994

1994

RECORD OF SURVEY FOR PROPERTY LINE ADJUSTMENT A PORTION OF THE THE SW 1/4 OF SECTION 3, TOWNSHIP 1 SOUTH, RANGE 24 EAST, W.M., MORROW COUNTY, OREGON

EXISTING LEGAL DESCRIPTIONS:

PROPERTY A:

(REFERENCE WARRANTY DEED M-40423, RECORDED MAY 11, 1993)

BEGINNING AT A POINT ON THE NORTH RIGHT OF WAY LINE OF THE O.W.R.&N. CO., IN SECTION 3, TOWNSHIP 1 SOUTH, RANGE 24, EAST OF THE WILLAMETTE MERIDIAN, SAID POINT BEING NORTH 87°20' EAST 8.93 CHAINS FROM THE INTERSECTION OF THE EAST LINE OF "H" STREET OF THE TOWN OF IONE, OREGON, AND THE NORTH RIGHT OF WAY LINE OF THE SAID O.W.R.&N. CO.; THENCE SOUTH 87°20' EAST 11.79 CHAINS ALONG SAID RIGHT OF WAY LINE; THENCE NORTH 04°20' EAST 6.38 CHAINS TO THE SOUTH RIGHT OF WAY LINE OF THE OREGON-WASHINGTON HIGHWAY, THENCE SOUTH 89°20' WEST 12.57 CHAINS, THENCE SOUTH 02°40' EAST 6.74 CHAINS TO THE PLACE OF BEGINNING, CONTAINING 7.99 ACRES, MORE OR LESS,

AND COMMENCING AT A POINT NORTH 54°37' EAST 10.36 CHAINS FROM THE CORNER OF SECTION 3, 4, 9 AND 10, TOWNSHIP 1 SOUTH, RANGE 24, EAST OF THE WILLAMETTE MERIDIAN, THE SAID POINT ALSO BEING SOUTH 47°30' EAST 1.22 CHAINS FROM THE SOUTHEAST CORNER OF LOT 8, BLOCK 7, CLUFF'S 7TH ADDITION TO IONE, THENCE AROUND THE TRACT AS FOLLOWS, TO WIT: NORTH 89°20' EAST 8.93 CHAINS, ALONG THE NORTH SIDE OF THE O.W.R.&N. CO. RIGHT OF WAY, THENCE NORTH 02°40' WEST 6.74 CHAINS ACROSS THE FIELD TO THE COUNTY ROAD, THENCE SOUTH 89°15' WEST 8.59 CHAINS, ALONG THE SOUTH SIDE OF SAID COUNTY ROAD, THENCE SOUTH 7.00 CHAINS TO THE PLACE OF BEGINNING, CONTAINING 6 ACRES, MORE OR LESS, TOGETHER WITH SUCH WATER RIGHTS AS ARE NOW GRANTED AND ALLOTTED BY THE STATE OF OREGON, AND COVERING PART OF THE ACREAGE OF THE ABOVE DESCRIBED PREMISES.

EXCEPTING THEREFROM, BEGINNING AT A POINT ON THE NORTH RIGHT OF WAY LINE OF THE O.W.R.&N. CO., IN SECTION 3, TOWNSHIP 1 SOUTH, RANGE 24, EAST OF THE WILLAMETTE MERIDIAN, SAID POINT BEING NORTH 87°20' EAST 20.72 CHAINS FROM THE INTERSECTION OF THE EAST LINE OF "H" STREET TO THE TOWN OF IONE, OREGON AND THE NORTH RIGHT OF WAY LINE OF THE O.W.R.&N. CO.; THENCE NORTH 04°20' EAST 6.38 CHAINS TO THE SOUTH RIGHT OF WAY LINE OF THE OREGON-WASHINGTON HIGHWAY; THENCE ALONG THE SAID RIGHT OF WAY LINE SOUTH 89°20' WEST 3.12 CHAINS; THENCE SOUTH 04°20' WEST 6.50 CHAINS TO THE NORTH RIGHT OF WAY LINE OF SAID O.W.R.&N. CO.; THENCE NORTH 87°20' EAST 3.12 CHAINS ALONG THE NORTH RIGHT OF WAY LINE OF SAID O.W.R.&N. CO., TO THE PLACE OF BEGINNING, CONTAINING 2 ACRES, MORE OR LESS.

PROPERTY B:

(REFERENCE QUITCLAIM DEED M-46070, RECORDED SEPT. 22, 1995)

ALL THAT PORTION OF THE "HEPPNER BRANCH" RIGHT OF WAY OF THE UNION PACIFIC RAILROAD COMPANY, SUCCESSOR IN INTEREST TO THE OREGON RAILWAY & NAVIGATION COMPANY AND THE OREGON-WASHINGTON RAILROAD & NAVIGATION COMPANY, SITUATED IN THE SOUTHEAST QUARTER OF THE SOUTHWEST QUARTER (SE1/4 OF SW1/4) AND THE SOUTHWEST QUARTER OF THE SOUTHWEST QUARTER (SW1/4 OF SW1/4) EASTERLY OF THE EAST RIGHT OF WAY LINE OF "H" STREET OF SECTION 3, TOWNSHIP 1 SOUTH, RANGE 24 EAST, WILLAMETTE MERIDIAN, PORTIONS OF THE AFORESAID TRACTS BEING SITUATED WITHIN THE LIMITS OF THE CITY OF IONE, MORROW COUNTY, OREGON AND PORTIONS BEING SITUATED WITHIN THE UNINCORPORATED PORTION OF SAID MORROW COUNTY.

PROPERTY C:

(REFERENCE PARCEL 1 OF SPECIAL WARRANTY DEED 2019-43801, RECORDED MARCH 1, 2019)

PARCEL 1 OF PARTITION PLAT 2007-05, IN THE COUNTY OF MORROW AND STATE OF OREGON.

TRANSFER LEGAL DESCRIPTIONS:

TRANSFER 1:

(FROM PROPERTY B TO PROPERTY A)

THAT PORTION OF THE "HEPPNER BRANCH" RIGHT OF WAY OF THE UNION PACIFIC RAILROAD COMPANY, SUCCESSOR IN INTEREST TO THE OREGON RAILWAY & NAVIGATION COMPANY AND THE OREGON-WASHINGTON RAILROAD & NAVIGATION COMPANY, SITUATED IN THE SOUTHWEST QUARTER OF THE SOUTHWEST QUARTER (SW1/4 OF SW1/4) EASTERLY OF THE EAST RIGHT OF WAY LINE OF "H" STREET OF SECTION 3, TOWNSHIP 1 SOUTH, RANGE 24 EAST, WILLAMETTE MERIDIAN DESCRIBED AS FOLLOWS:

BEGINNING AT THE INTERSECTION OF SAID EAST LINE OF "H" STREET AND THE NORTH RIGHT OF WAY LINE OF SAID "HEPPNER BRANCH"; THENCE NORTH 86°48'06" EAST 448.07 FEET ALONG SAID NORTH RIGHT OF WAY LINE; THENCE SOUTH 2°10'06" EAST 48.00 FEET TO A POINT LYING 48.00 FEET SOUTHERLY OF SAID NORTH RIGHT OF WAY LINE WHEN MEASURED AT RIGHT ANGLES; THENCE SOUTH 86°48'06" WEST 449.48 FEET ALONG A LINE 48.00 FEET SOUTHERLY OF AND PARALLEL WITH SAID NORTH RIGHT OF WAY LINE; THENCE NORTH 0°28'54" WEST 48.05 FEET ALONG THE EAST LINE OF SAID "H" STREET TO THE POINT OF BEGINNING. CONTAINING 0.49 ACRES, MORE OR LESS.

TRANSFER 2:

(FROM PROPERTY A TO PROPERTY B)

THAT PORTION OF THE SOUTHWEST QUARTER OF SECTION 3, TOWNSHIP 1 SOUTH, RANGE 24 EAST, WILLAMETTE MERIDIAN DESCRIBED AS FOLLOWS:

COMMENCING AT THE INTERSECTION OF THE EAST LINE OF "H" STREET AND THE NORTH RIGHT OF WAY LINE OF THE "HEPPNER BRANCH" OF THE UNION PACIFIC RAILROAD COMPANY, SUCCESSOR IN INTEREST TO THE OREGON RAILWAY & NAVIGATION COMPANY AND THE OREGON-WASHINGTON RAILROAD & NAVIGATION COMPANY; THENCE NORTH 86°48'06" EAST 448.07 FEET ALONG SAID NORTH LINE TO THE POINT OF BEGINNING; THENCE CONTINUING NORTH 86°48'06" EAST 712.97 FEET ALONG SAID NORTH LINE TO THE SOUTHWEST CORNER OF THAT PROPERTY DESCRIBED IN DEED CONVEYED TO ROBIN KREBS RECORDED NOVEMBER 09, 2007 UNDER INSTRUMENT NUMBER 2007-20757; THENCE NORTH 3°22'48" EAST 430.13 FEET, MORE OR LESS ALONG THE WEST LINE OF SAID KREBS DESCRIPTION TO THE SOUTHERLY RIGHT OF WAY LINE OF THE HEPPNER HIGHWAY; THENCE SOUTH 88°40'51" WEST 738.83 FEET ALONG SAID SOUTHERLY RIGHT OF WAY TO THE BEGINNING OF A 1402.39 FEET RADIUS CURVE CONCAVE TO THE SOUTH (THE LONG CHORD OF WHICH BEARS SOUTH 88°21'36" WEST 15.70 FEET); THENCE WESTERLY 15.70 FEET ALONG THE ARC OF SAID CURVE THROUGH A CENTRAL ANGLE OF 0°38'29"; THENCE SOUTH 2°10'06" EAST 452.03 FEET TO THE NORTH RIGHT OF WAY LINE OF THE "HEPPNER BRANCH" AND THE POINT OF BEGINNING. CONTAINING 7.41 ACRES, MORE OR LESS.

TRANSFER 3:

(FROM PROPERTY B TO PROPERTY C)

THAT PORTION OF THE "HEPPNER BRANCH" RIGHT OF WAY OF THE UNION PACIFIC RAILROAD COMPANY, SUCCESSOR IN INTEREST TO THE OREGON RAILWAY & NAVIGATION COMPANY AND THE OREGON-WASHINGTON RAILROAD & NAVIGATION COMPANY, SITUATED IN THE SOUTHEAST QUARTER OF THE SOUTHWEST QUARTER (SE1/4 OF SW1/4) OF SECTION 3, TOWNSHIP 1 SOUTH, RANGE 24 EAST, WILLAMETTE MERIDIAN LYING EASTERLY OF THE FOLLOWING DESCRIBED LINE:

COMMENCING AT THE INTERSECTION OF THE EAST LINE OF "H" STREET AND THE NORTH RIGHT OF WAY LINE OF SAID "HEPPNER BRANCH"; THENCE NORTH 86°48'06" EAST 1,161.60 FEET ALONG SAID NORTH LINE TO THE SOUTHWEST CORNER OF THAT PROPERTY DESCRIBED IN DEED CONVEYED TO ROBIN KREBS RECORDED NOVEMBER 09, 2007 UNDER INSTRUMENT NUMBER 2007-20757 AND THE TRUE POINT OF BEGINNING; THENCE SOUTH 3°22'48" WEST 100.66 FEET, MORE OR LESS, ALONG THE SOUTHWESTERLY PROJECTION OF THE WEST LINE OF SAID KREBS DESCRIPTION TO THE SOUTHERLY RIGHT OF WAY LINE OF SAID "HEPPNER BRANCH" AND THE TERMINUS OF SAID DESCRIBED LINE. CONTAINING 2.16 ACRES, MORE OR LESS.

RESULTANT LEGAL DESCRIPTIONS:

PROPERTY 1:

THAT PORTION OF THE SOUTHWEST QUARTER OF SECTION 3, TOWNSHIP 1 SOUTH, RANGE 24 EAST, WILLAMETTE MERIDIAN DESCRIBED AS FOLLOWS:

BEGINNING AT THE INTERSECTION OF THE EAST LINE OF "H" STREET AND THE NORTH RIGHT OF WAY LINE OF THE "HEPPNER BRANCH" OF THE UNION PACIFIC RAILROAD COMPANY, SUCCESSOR IN INTEREST TO THE OREGON RAILWAY & NAVIGATION COMPANY AND THE OREGON-WASHINGTON RAILROAD & NAVIGATION COMPANY; THENCE SOUTH 0°28'54" EAST 48.05 FEET ALONG SAID EAST LINE TO A POINT LYING 48.00 FEET SOUTHERLY OF SAID NORTH RIGHT OF WAY LINE WHEN MEASURED AT RIGHT ANGLES; THENCE NORTH 86°48'06" EAST 449.48 FEET ALONG A LINE 48.00 FEET SOUTHERLY OF AND PARALLEL WITH SAID NORTH RIGHT OF WAY LINE OF THE "HEPPNER BRANCH"; THENCE NORTH 2°10'06" WEST 500.03 FEET TO A POINT ON THE SOUTHERLY RIGHT OF WAY LINE OF THE HEPPNER HIGHWAY; SAID POINT BEING ON A 1402.39 FEET RADIUS CURVE CONCAVE TO THE SOUTH (THE LONG CHORD OF WHICH BEARS SOUTH 80°15'16" WEST 351.61 FEET); THENCE WESTERLY 352.54 FEET ALONG THE ARC OF SAID CURVE AND SAID SOUTHERLY RIGHT OF WAY LINE THROUGH A CENTRAL ANGLE OF 14°24'11"; THENCE SOUTH 73°38'10" WEST 90.12 FEET ALONG SAID SOUTHERLY RIGHT OF WAY LINE TO THE INTERSECTION WITH THE EAST LINE OF SAID "H" STREET; THENCE SOUTH 0°28'54" EAST 443.39 FEET ALONG SAID EAST LINE TO THE INTERSECTION WITH THE NORTH RIGHT OF WAY LINE OF SAID "HEPPNER BRANCH" AND THE POINT OF BEGINNING. CONTAINING 4.89 ACRES, MORE OR LESS.

PROPERTY 2:

THAT PORTION OF THE SOUTHWEST QUARTER OF SECTION 3, TOWNSHIP 1 SOUTH, RANGE 24 EAST, WILLAMETTE MERIDIAN DESCRIBED AS FOLLOWS:

COMMENCING AT THE INTERSECTION OF THE EAST LINE OF "H" STREET AND THE NORTH RIGHT OF WAY LINE OF THE "HEPPNER BRANCH" OF THE UNION PACIFIC RAILROAD COMPANY, SUCCESSOR IN INTEREST TO THE OREGON RAILWAY & NAVIGATION COMPANY AND THE OREGON-WASHINGTON RAILROAD & NAVIGATION COMPANY; THENCE SOUTH 0°28'54" EAST 100.11 FEET ALONG SAID EAST LINE TO THE INTERSECTION OF SAID EAST LINE WITH THE NORTH RIGHT OF WAY LINE OF SAID "HEPPNER BRANCH", SAID INTERSECTION BEING THE NORTHWEST CORNER OF THAT PROPERTY DESCRIBED IN STATUTORY WARRANTY DEED CONVEYED TO CHRISTMAN RECORDED JUNE 25, 2009 UNDER INSTRUMENT NUMBER 2009-24234 AND THE POINT OF BEGINNING; THENCE NORTH 86°48'06" EAST 1154.25 FEET ALONG SAID SOUTH RIGHT OF WAY LINE TO THE INTERSECTION OF THE SOUTHWESTERLY PROJECTION OF THE WEST LINE OF THAT PROPERTY DESCRIBED IN DEED CONVEYED TO ROBIN KREBS RECORDED NOVEMBER 09, 2007 UNDER INSTRUMENT NUMBER 2007-20757 AND THE SOUTH RIGHT OF WAY LINE OF SAID "HEPPNER BRANCH"; THENCE NORTH 3°22'48" EAST 530.79 FEET, MORE OR LESS ALONG THE WEST LINE OF SAID KREBS DESCRIPTION AND THE SOUTHWESTERLY PROJECTION THEREOF TO THE SOUTHERLY RIGHT OF WAY LINE OF THE HEPPNER HIGHWAY; THENCE SOUTH 88°40'51" WEST 738.83 FEET ALONG SAID SOUTHERLY RIGHT OF WAY TO THE BEGINNING OF A CURVE CONCAVE TO THE SOUTH (THE LONG CHORD OF WHICH BEARS SOUTH 88°21'36" WEST 15.70 FEET); THENCE WESTERLY 15.70 FEET ALONG THE ARC OF SAID CURVE THROUGH A CENTRAL ANGLE OF 0°38'29"; THENCE SOUTH 2°10'06" EAST 500.03 FEET TO A POINT LYING 48.00 FEET SOUTHERLY OF THE NORTH RIGHT OF WAY LINE OF SAID "HEPPNER BRANCH" WHEN MEASURED AT RIGHT ANGLES; THENCE SOUTH 86°48'06" WEST 449.48 FEET ALONG A LINE 48.00 FEET SOUTHERLY OF AND PARALLEL WITH SAID NORTH RIGHT OF WAY LINE OF THE "HEPPNER BRANCH" TO THE EAST LINE OF SAID "H" STREET; THENCE SOUTH 0°28'54" EAST 52.06 FEET ALONG SAID EAST LINE TO THE SOUTH RIGHT OF WAY LINE OF THE "HEPPNER BRANCH" AND THE POINT OF BEGINNING. CONTAINING 9.58 ACRES, MORE OR LESS.

PROPERTY 3:

PARCEL 1 OF PARTITION PLAT 2007-05, IN THE COUNTY OF MORROW AND STATE OF OREGON.

TOGETHER WITH THAT PORTION OF THE "HEPPNER BRANCH" RIGHT OF WAY OF THE UNION PACIFIC RAILROAD COMPANY, SUCCESSOR IN INTEREST TO THE OREGON RAILWAY & NAVIGATION COMPANY AND THE OREGON-WASHINGTON RAILROAD & NAVIGATION COMPANY, SITUATED IN THE SOUTHEAST QUARTER OF THE SOUTHWEST QUARTER (SE1/4 OF SW1/4) OF SECTION 3, TOWNSHIP 1 SOUTH, RANGE 24 EAST, WILLAMETTE MERIDIAN LYING EASTERLY OF THE FOLLOWING DESCRIBED LINE:

COMMENCING AT THE INTERSECTION OF THE EAST LINE OF "H" STREET AND THE NORTH RIGHT OF WAY LINE OF SAID "HEPPNER BRANCH"; THENCE NORTH 86°48'06" EAST 1,161.60 FEET ALONG SAID NORTH LINE TO THE SOUTHWEST CORNER OF THAT PROPERTY DESCRIBED IN DEED CONVEYED TO ROBIN KREBS RECORDED NOVEMBER 09, 2007 UNDER INSTRUMENT NUMBER 2007-20757; THENCE SOUTH 3°22'48" WEST 100.66 FEET, MORE OR LESS, ALONG THE SOUTHWESTERLY PROJECTION OF THE WEST LINE OF SAID KREBS DESCRIPTION TO THE SOUTHERLY RIGHT OF WAY LINE OF SAID "HEPPNER BRANCH" AND THE TERMINUS OF SAID DESCRIBED LINE.

REGISTERED
PROFESSIONAL
LAND SURVEYOR
Brenton A. Griffin
OREGON
MARCH 09, 2021
BRENTON A. GRIFFIN
93754PLS
RENEWS: 06/30/2023

DATE: 6/06/2022

REV: 6/03/22 BAG

Curve Table								
CURVE	LENGTH	RADIUS	DELTA	CH. BRNG.	CHORD	RADIUS (R)	DELTA (R)	LENGTH (R)
C1	1767.28	5729.65	17°40'21"	N84°21'43"W	1760.28	1'CR(5729.65')	17°42'	1770
C11	411.67	1909.86	12°21'00"	N85°08'39"W	410.87	3'CR(1909.86')	12°21'	411.70
C12	654.59	1432.40	26°11'00"	N65°52'39"W	648.90	4'CR(1432.40')	26°11'	654.60

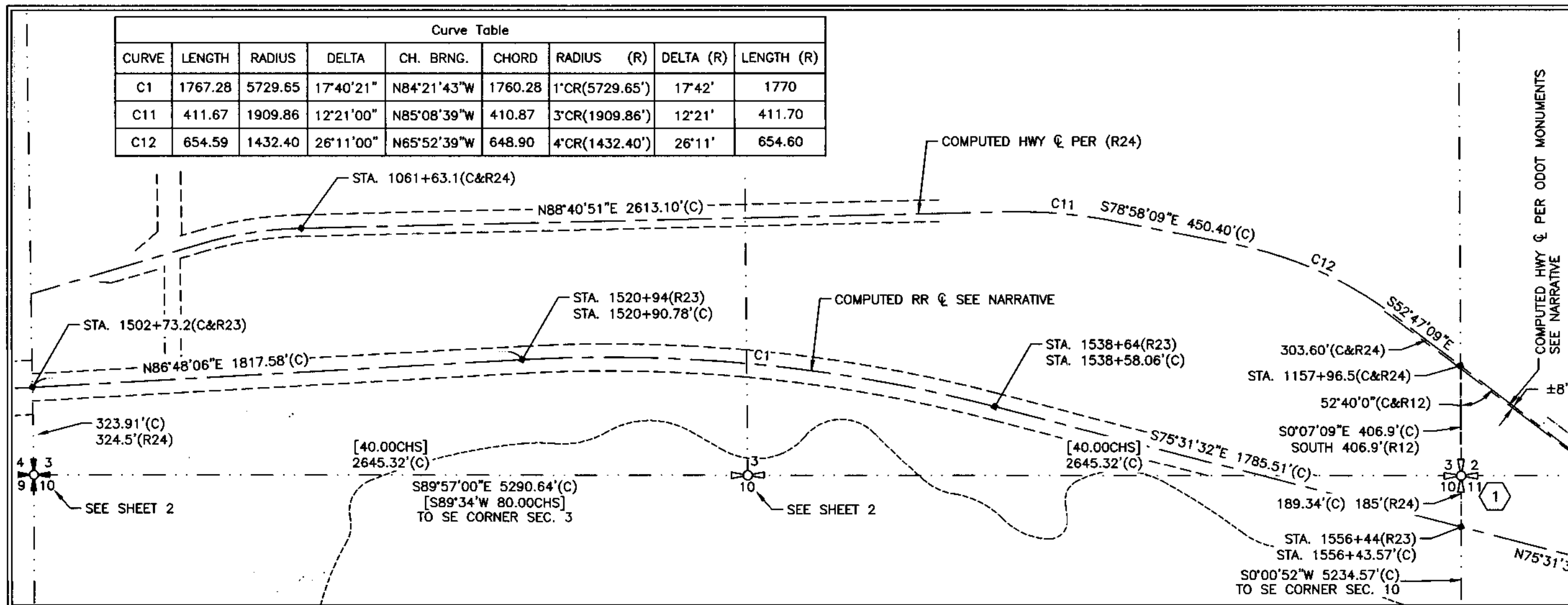

1 SET 5/8"X30" REBAR W/ 2" ALUMINUM CAP, ±1.5' BELOW GROUND. STAMPED AS SHOWN



DETAIL 5
SCALE: 1"=400'

RECEIVED BY
Morrow County Surveyor
Date: 6-24-22
Rec'd By: MPK
No.: 2022-1994C
Folder No.: 1994

RSI ROGERS SURVEYING INC., P.S.
1455 COLUMBIA PARK TRAIL
RICHLAND, WA. 99352
PHONE (509) 783-4141
FAX: (509) 783-8994
www.rogerssurveying.com

CLIENT	IONE SCHOOL DISTRICT	JOB	06622
PROJECT	PROPERTY LINE ADJUSTMENT PTN SW1/4 SEC 3, T.1S., R24E., W.M.	DRN. BY	BAG
SCALE	1"=1000'	DATE	4/12/2022
APPROVED	BAG	FILE:	06622.DWG
F. B. NO. BK 876	ACAD VER - C3D21	SHEET	3
OF	4		

1994

1994

RECORD OF SURVEY FOR PROPERTY LINE ADJUSTMENT A PORTION OF THE THE SW 1/4 OF SECTION 3, TOWNSHIP 1 SOUTH, RANGE 24 EAST, W.M., MORROW COUNTY, OREGON

NARRATIVE

THIS SURVEY WAS PERFORMED AT THE REQUEST OF THE IONE SCHOOL DISTRICT TO ADJUST THE BOUNDARIES OF THE PROPERTIES OWNED BY JAMES KING TO RESULT IN A CONFIGURATION OF "PROPERTY 2" AS SHOWN HEREON FOR A FUTURE PURCHASE. THE TAX LOTS INVOLVED IN THE ADJUSTMENT ARE TAX LOT 400, MAP 01S24E03CC, TAX LOT 400 01S24E03CD, TAX LOT 400, MAP 01S24E03C AND TAX LOT 400 MAP 01S24E03.

THE LEGAL DESCRIPTIONS FOR MR. KING'S PROPERTY ALL BEGIN OR COMMENCE FROM THE INTERSECTION OF THE EAST LINE OF "H" STREET AND THE NORTH RIGHT OF WAY LINE OF THE O.W.R.&N. CO. ALSO REFERRED TO AS THE "HEPPNER BRANCH" BY THE UNION PACIFIC RAILROAD COMPANY AS SUCCESSOR TO O.W.R.&N. CO.

"H" STREET, AS SHOWN ON THE PLATS OF CLUFF'S SEVENTH AND EIGHTH ADDITIONS WAS COMPUTED HEREON BY ROTATING THE PERFECT NORTH-SOUTH AND EAST-WEST NATURE OF SAID SUBDIVISIONS FROM AN ASSUMED "TRUE" BEARING BASIS TO A U.S. STATE PLANE "GRID" BEARING BASIS. I USE CORPSCON V6.0 TO COMPUTE A CONVERGENCE ANGLE OF 0°28'54.17" AT THE SOUTHWEST CORNER OF SECTION 3 BEING THE BRASS CAP MONUMENT SET BY KRUMBEIN IN SURVEY NO. B-658-K (FOLDER 238) (R4). THE PLATS WERE ROTATED TO THIS CONVERGENCE ANGLE AND MAINTAIN A PERPENDICULAR RELATIONSHIP. ONCE ROTATED, THE COMPUTED EAST RIGHT OF WAY LINE FOR "H" STREET MATCHES THE EXISTING FENCE LOCATION RUNNING NORTH AND SOUTH ALONG SAID EAST LINE. THE COMPUTED LOCATION FOR "H" STREET WAS HELD TO CONTROL THE PROPERTY BOUNDARY OVER THE SOUTHERLY PROJECTION OF THE EASTERLY RIGHT OF WAY LINE FOR ELLA ROAD MONUMENTED BY EDWARDS IN THE PLAT OF EMERT SUBDIVISION (R1) AS THIS SOUTHERLY PROJECTION DOES NOT MATCH THE FENCE LOCATION OR LOCATION OF EXISTING "H" STREET.

LITTLE TO NO EVIDENCE OF THE ORIGINAL RAILROAD LOCATION STILL EXISTS WITHIN THE LIMITS OF THIS SURVEY. TO COMPUTE THE RIGHT OF WAY LINE FOR THE RAILROAD I REBUILD THE CENTERLINE OF SAID RIGHT OF WAY AT A 100.00 FEET OFFSET SOUTH FROM THE FOUND MONUMENTS SET BY KRUMBEIN IN SURVEY NO B-841-K (FOLDER 258) MARKING THE NORTH RIGHT OF WAY LINE FOR SAID RAILROAD IN SECTION 4. I EXTEND THE CENTERLINE EASTERLY TO CREATE THE TANGENT OF SAID RIGHT OF WAY THROUGH THE SUBJECT PROPERTIES. THE FOUND 1934 U.S.C.&G.S. BRASS CAP DESIGNATED G87, AS SHOWN IN DETAIL 3, WAS BELIEVED TO BE DISTURBED ACCORDING TO NEIGHBORING LAND OWNERS. I DO NOT FIND THIS MONUMENT TO BE DISTURBED AS ITS POSITION AND RELATION TO THE SOUTH RAIL AS STATED IN THE NGS DATASHEET IS SURPRISINGLY CONSISTENT WITH THE COMPUTED RAIL CENTERLINE AS DESCRIBED ABOVE. THE DATASHEET (R17) LISTS A CALL OF 46.0 FEET TO THE SOUTH RAIL. I ASSUME THIS BEING REFERENCE TO BE MEASURED TO THE CENTER OF THE SOUTH RAIL AND AN ADDITIONAL 2.46' BEING THE SPLIT OF A STANDARD INTERIOR RAIL-RAIL DIMENSION OF 4.71' AND A SPLIT OF AN ASSUMED RAIL WIDTH OF 0.22'. THESE ASSUMPTIONS PLACE THE MONUMENT WITHIN 0.1' OF MY COMPUTED CENTERLINE. THE DATASHEET ALSO LISTS A CALL OF 0.3' NORTH OF A FENCE AND SET IN CONCRETE PROJECTING 0.2' ABOVE THE GROUND WHICH ARE BOTH CONSISTENT WITH WHAT I WITNESSED. FURTHERMORE THE DATASHEET HAS A PUBLISHED NAVD_88 ADJUSTED ELEVATION OF 1096.70' WHICH I MATCH WITHIN 0.03' FROM MY MEASURED RTK OBSERVATIONS PROCESSED USING OPUS. I BELIEVE THE MONUMENT HAS NOT SIGNIFICANTLY MOVED AND USE ITS POSITION TO VERIFY MY COMPUTED CENTERLINE LOCATION. ADDITIONALLY, THE COMPUTED POSITION FOR THE EAST LINE OF BLOCK 5, PLAT OF CLUFF'S SEVENTH ADDITION IS CONSISTENT WITH THE SOUTH RIGHT OF WAY AS COMPUTED. FURTHERMORE THE COMPUTED POSITION FOR THE NORTHERLY RIGHT OF WAY LINE FOR MCGEE STREET FROM THE PLAT OF CLUFF'S EIGHTH ADDITION IS CONSISTENT WITH BOTH THE SOUTH RIGHT OF WAY LINE OF THE RAILROAD AND THE DEED CALL PRESENT IN (D5). NO BOUNDS CALL TO THE SOUTH RIGHT OF WAY LINE FOR THE RAILROAD WAS INCLUDED IN THE LEGAL DESCRIPTION OF (D5) BUT IS CLEAR IN ITS INTENT GIVEN THE COMPUTED LOCATIONS OF BOTH THE RAILROAD AND CLUFF'S EIGHTH ADDITIONS TO BOUND ON SAID SOUTHERLY RIGHT OF WAY LINE. THE SOUTHERLY RAILROAD RIGHT-OF-WAY IS ALSO CONSISTENT WITH THE NORTH SIDE OF THE GRAIN BUILDING SITUATE BETWEEN "F" AND "G" STREETS NORTH OF MCGEE STREET (SEE SHEET 2).

TO COMPUTE THE CURVE IN THE CENTERLINE OF THE RAILROAD I USE THE RECORD CURVE INFORMATION PRESENT ON OREGON STATE HIGHWAY DEPARTMENT MAP 4B-2-4 (R12) AND ON O.W.R.&N.CO. RIGHT-OF-WAY AND TRACK MAP V-ORE.8 08 (R23) WHICH LIST A 1' CURVE TO THE RIGHT BETWEEN THE TANGENTS. TO ESTABLISH THE LOCATION FOR THE TANGENT AHEAD I ASBUILT WHAT LITTLE PHYSICAL EVIDENCE I FIND BEING EVIDENCE OF THE OLD RAILROAD BERM ACCORDING TO LOCAL LAND OWNERS AND THE SPLIT OF ROCK FACES WITHIN THE GRADING NOTCH CUT THROUGH ROCK LEDGE AT OLD RAILROAD TRACK LOCATION AS BEST AVAILABLE EVIDENCE. THE RESULTANT COMPUTED CURVE DATA MATCHES CLOSELY WITH THE DATA OF RECORD (R12) AND (R23) AND FITS THE FENCE LOCATION LOCATED ON THE SWANSON PROPERTY (D4) EAST OF THE SUBJECT PROPERTY FOR THIS SURVEY.

THE SOUTHERLY RIGHT OF WAY FOR HIGHWAY 74 WAS ESTABLISHED AT A 130.00 FEET OFFSET SOUTH FROM THE MONUMENTS SET BY EDWARDS ALONG THE NORTHERLY RIGHT OF WAY OF SLIM LANE AS SHOWN ON SAID PLAT OF EMERT SUBDIVISION (R1). THIS LOCATION CONFORMS WITH THE AS-BUILT CENTERLINE OF THE HIGHWAY AND WITH THE EXISTING FENCE LINE PRESENT ALONG THE NORTH LINE OF PROPERTIES DESCRIBED IN DEEDS (D1), (D3) AND (D4). DISCREPANCIES EXIST IN HIGHWAY STATIONING FOR HIGHWAY MONUMENTS FOUND WEST AND EAST OF THE SUBJECT PROPERTY. MONUMENTS SET BY ODOT IN SURVEY NO. D-1078-E (FOLDER 851) (R2) ARE SHOWN FOR REFERENCE ONLY AND WERE NOT HELD TO CONTROL THE RIGHT OF WAY FOR THE HIGHWAY EAST OF ELLA RD/"H" STREET. THE ODOT MONUMENTS FOUND EAST OF THE SUBJECT PROPERTY WERE NOT USED TO REESTABLISH THE POSITION FOR THE SOUTHEAST CORNER OF SECTION 3 (SEE DETAIL 1, SHEET 1 AND DETAIL 5, SHEET 3). THESE MONUMENTS ARE MARKING THE RIGHT OF WAY CHANGES PRESENTED IN ODOT SURVEYS 9B-21-9 (R15) AND 9B-21-19 (R16). THE STATIONS POSTED ON THE "SHRW" AND "SHRP" MARKER BOARD SIGNS AS MENTIONED DO NOT LINE UP WITH THE STATIONING PRESENT FOR THE MONUMENTS FOUND FROM (R2) WHEN USING ODOT SURVEYS 7B-6-15 (R13), 7B-6-16 (R14) AND 3B-11-14 (R24) TO COMPUTE THE CENTERLINE EAST FROM (R2). FURTHERMORE, THE COMPUTED HIGHWAY CENTERLINE USING THE FOUND MONUMENTS FROM SURVEYS (R15) AND (R16) DOES NOT MATCH THE COMPUTED CENTERLINE LOCATION PER (R13) AND (R14) WHEN USING THE EDWARDS MONUMENTS AS DESCRIBED ABOVE.

TO REESTABLISH THE SECTION CORNER POSITION COMMON TO SECTIONS 2, 3, 9 & 10, I REBUILD THE HIGHWAY CENTERLINE EAST FROM THE EASTERLY END OF CURVE C2 COMPUTED FROM FOUND EDWARDS MONUMENTS BEING HWY STATION 1061+63.1 PER (R24) (SEE DETAIL 5, SHEET 3). I THEN COMPUTE THE POSITION OF STA. 1157+96.5 AT 303.6 FEET SOUTHEASTERLY ALONG SAID CENTERLINE FROM THE END OF CURVE C12 AS SHOWN IN SAID DETAIL 5. THIS COMPUTED HIGHWAY CENTERLINE IS CONSISTENT WITH THE PHYSICAL LOCATION OF THE BUILT HIGHWAY. I USE THE SECTION CORNER TIE PRESENT IN (R12) TO COMPUTE THE SECTION CORNER FROM SAID STA. 1157+96.5. THIS SECTION CORNER LOCATION FITS WELL WITH OCCUPATIONAL EVIDENCE ALONG THE LINE BETWEEN SECTIONS 2 AND 3 TO THE NORTH AND WITH OCCUPATION EVIDENCE ALONG THE LINE BETWEEN SECTIONS 10 AND 11 TO THE SOUTH. THE POSITION IS ALSO CONSISTENT WITH GLO RECORDS TO MONUMENTS FOUND AT THE SOUTHWEST CORNER OF SECTION 3 AND TO THE SOUTH QUARTER CORNER OF SECTION 1. THIS POSITION ALSO FITS WITH THE STATION AND OFFSET CALL PRESENT IN THE O.W.R.&N.CO. ROW MAP (R23) TO PLACE THE SECTION CORNER WITHIN 5 FEET OF MY COMPUTED RAIL LOCATION. I ELECT TO REJECT THE ODOT MONUMENTS MARKING THE SPIRAL CURVE (SEE DETAIL 1, SHEET 1) IN RESETTING THE SECTION CORNER AS THEY DO NOT MATCH THE STATION OR AS-BUILT CENTERLINE HIGHWAY LOCATION USED TO COMPUTE THE SECTION CORNER POSITION THAT IS CONSISTENT BETWEEN (R12) AND (R23) AS DESCRIBED ABOVE.

MULTIPLE DAYS OF FIELD SEARCHING WERE CONDUCTED TO VERIFY THIS COMPUTED POSITION AGAINST OTHER CADASTRAL EVIDENCE FOUND IN THE SURROUNDING SECTIONS. IN ROUGH EVALUATION IT APPEARS THAT THERE IS A DISCREPANCY BETWEEN THE LOCATION OF THE N 1/16TH CORNER BETWEEN SECTIONS 2 AND 3. FOR SECTION 3, COPPOCK IN PARTITION PLAT 2007-1 (R21) ESTABLISHES THE SOUTH LINE OF THE NORTH HALF OF THE NORTH HALF OF THE SECTION AT SINGLE PROPORTION POSITION BETWEEN THE NORTHEAST CORNER OF SECTION 3 AND THE EAST QUARTER CORNER OF SECTION 3, BEING A WESTERLY PROJECTION OF THE FENCE WHICH RUNS ALONG THE APPARENT E-W MID SECTION LINE OF SECTION 2. THIS FENCE, AS IT JOGS AROUND THE EAST AND NORTH LINES OF THE SOUTHWEST QUARTER OF THE NORTHWEST QUARTER OF SECTION 2, INTERSECTS THE SECTION LINE APPROXIMATELY 105 FEET SOUTH OF COPPOCK'S COMPUTED POSITION. AT THE SOUTHWEST CORNER OF THE FENCE TEE I FIND A 18"x15"x10" STONE OF UNKNOWN ORIGIN THAT MATCHES IN SIZE, SHAPE AND APPEARANCE TO THE STONE FOUND IN THE VICINITY OF THE EAST QUARTER CORNER POSITION OF SECTION 10 TO THE SOUTH. BOTH OF THESE STONES CONTAIN PHYSICAL EVIDENCE OF FENCES BEING BUILT TO THEIR LOCATIONS BUT ARE NOT EVALUATED HEREON AS BEING THE CADASTRAL CORNER MONUMENTS.

AT THE SOUTHEAST CORNER OF SECTION 10 I FIND A 16"x10"x8" STONE IN A MOUND OF STONE AT THE 1979 POSITION USED BY GILLESPIE IN SURVEY NO. 2015-1744C (FOLDER 1744) (R3). THIS SECTION CORNER POSITION IS CONSISTENT WITH GLO RECORDS FOR THE EAST LINE OF THE SOUTHWEST QUARTER OF SECTION 10 AND THE SOUTH LINE OF THE SOUTHEAST QUARTER OF SECTION 10. I REMONUMENT THIS STONE WITH A ALUMINUM A-1 STYLE MONUMENT AND BURY THE STONE ON ITS SIDE ±1 FOOT NORTH OF SAID MONUMENT.

AT THE SOUTH QUARTER CORNER OF SECTION 10 I FIND A 2"x2" WOODEN HUB IN A 4' DIAMETER MOUND OF STONE. NO EVIDENCE OF THE "FND. STONE MKD. 1/4" PER SURVEY NO. 2015-1730D (FOLDER 1730) (R7) WAS FOUND. TO PRESERVE THIS POSITION I DRIVE A 5/8" DIAMETER X 24" LONG REBAR IN THE POSITION OF THE WOODEN HUB AND SET A 2" ALUMINUM CAP WITH APPROPRIATE QUARTER CORNER STAMPINGS FOR THE CORNER POSITION.

NO DEED WAS FOUND FOR THE POTENTIAL RIGHT OF WAY TAKING FROM THE STATE OF OREGON FOR THE REALIGNMENT OF OR 74 IN THE NORTHWEST CORNER OF PROPERTY 1 (SEE DETAIL 4, SHEET 2). CONVERSATIONS WITH ODOT STAFF UNCOVERED ODOT SURVEY 3B-11-14 (R24) WHICH SHOWS THE HIGHWAY LOCATION VARYING FROM ODOT SURVEY 4B-2-4 (R12). THE RECORD LEGAL DESCRIPTION FOR PROPERTY A MAKES A BOUNDS CALL OF "ACROSS THE FIELD TO THE COUNTY ROAD" THENCE PROCEEDS WESTERLY "ALONG THE SOUTH SIDE OF THE COUNTY ROAD" AND FOLLOWS MORE CLOSELY THE RIGHT-OF-WAY SHOWN IN ODOT SURVEY 4B-2-4 (R12). THE IMPROVEMENTS BUILT ALONG THIS STRETCH OF PROPERTY FOLLOW THE SOUTHERLY RIGHT OF WAY LINE FOR THE HIGHWAY, AS HEREBY ESTABLISHED PER FOUND EDWARDS MONUMENTS, AND MATCH THE RIGHT OF WAY PRESENT IN ODOT MAPS 7B-6-15 (R13) AND 3B-11-14 (R24). THE ORIGINAL PROPERTY DESCRIPTION IS WRITTEN TO BOUND ON THE COUNTY ROAD PRIOR TO THE RIGHT OF WAY LOCATION AS SHOWN ON ODOT MAP 4B-2-4 (R12). THIS SURVEY MONUMENTS THE SOUTHERLY RIGHT OF WAY AS SHOWN ON THE HIGHWAY PLANS PER (R13) AND (R24).

REGISTERED
PROFESSIONAL
LAND SURVEYOR
Brenton A. Griffin
OREGON
MARCH 09, 2021
BRENTON A. GRIFFIN
93754PLS

6/06/2022
DATE

RENEWS: 06/30/2023

REV: 6/03/22 BAG

RECEIVED BY
Morrow County Surveyor
Date: 6-24-22
Rec'd By: MPK
No.: 2022-1994 C
Folder No.: 1994

RSI ROGERS
SURVEYING INC., P.S.
1455 COLUMBIA PARK TRAIL
RICHLAND, WA. 99352
PHONE (509) 783-4141
FAX: (509) 783-8994
www.rogerssurveying.com

CLIENT	IONE SCHOOL DISTRICT		JOB	06622
PROJECT	PROPERTY LINE ADJUSTMENT PTN SW1/4 SEC 3, T.1S., R24E., W.M.			
DRN. BY	BAG	SCALE	1"=1000'	F. B. NO. BK 876
APPROVED	BAG	DATE	4/12/2022	ACAD VER - C3D21
				FILE: 06622.DWG
				SHEET 4 OF 4

1994